



DATA SHEET

DAB PUMPS S.p.A.
Via Marco Polo, 14 - 35035 Mestrino (PD), Italy
Tel. +39 049 5125000 - Fax +39 049 5125950
www.dabpumps.com

31/07/2016

Page 1 / 3

Receiver

From

Society
Reference
Address
Phone
Fax
E-mail

Item n° :

505940622

Model :

BMH 30/340.65 T

Pump data

Pressure rating : PN 10
Min. fluid temperature : -10 °C
Max. fluid temperature : 120 °C

Minimum suction head :

Temperature	°C	75	90	110	120
Minimum suction head :	m	4	7,5	--	21

Requested data

Flow :
Head :
Fluid (%) :
Fluid Temperature : 20 °C
Density : 998,3 kg/m³
Kinematic viscosity : 1,005 mm²/s
Vapor pressure :

Hydraulic data (duty point)

Flow :
Head :

Materials

Pump body	Cast iron 200 UNI ISO 185
Impeller	Technopolymer B
Motor shaft	AISI 420 C
Air vent plug	Brass P Cu Zn40 Pb2 UNI 5705
Seal ring	Ethylene propylene (EPDM)
Motor casing	Die cast aluminium
Stator jacket	AISI 321Bon. - AISI 304

Curve tolerance according to ISO 9906

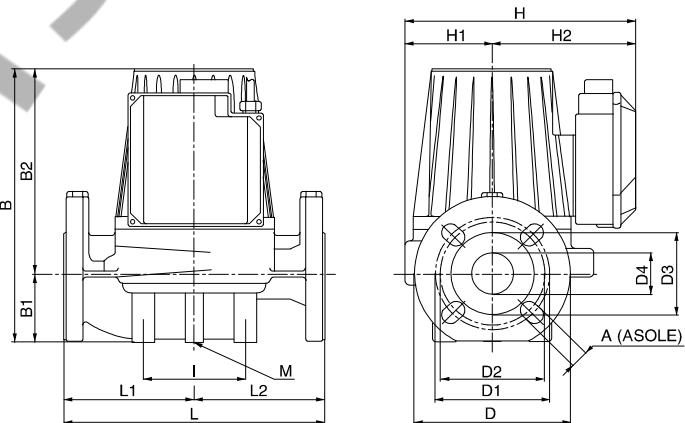
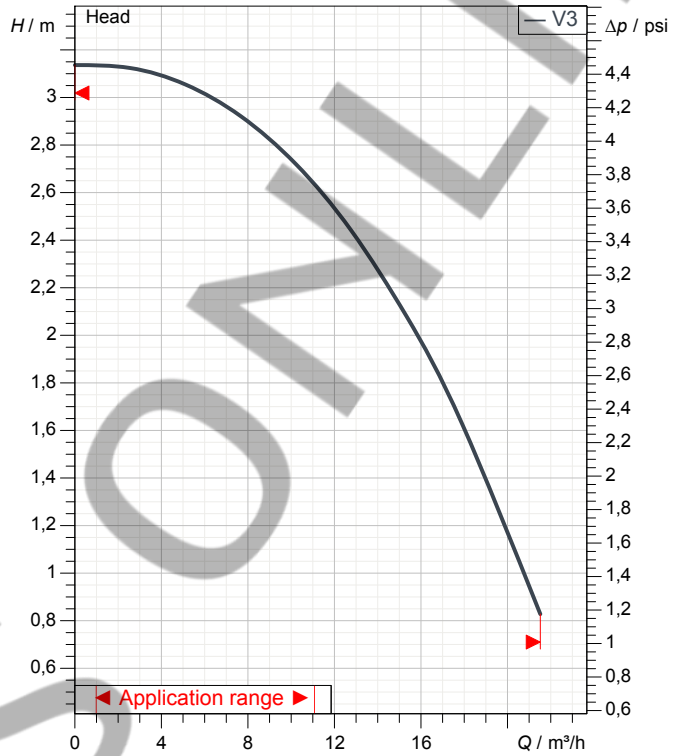

Motor data

Motor brand : DAB
Power input P1 : 0,27 kW
Rated speed : 1450 1/min
Rated voltage : 3~ 400 V 50 Hz
Nominal current : 1,12 A
Degree of protection : IP 44

Dimensions in mm

A	18	D1	145	H1	100	I3	-
B	334	D2	130	H2	159	L	340
B1	82	D3	110	I	100	L1	170
B2	252	D4	65	I1	-	L2	170
D	185	H	259	I2	-	M	M12

Weight : 27,5 kg

Pump connection

Suction side : DN 65 / PN 10
Discharge side : DN 65 / PN 10



PERFORMANCE CURVES

31/07/2015

Page 2 / 3

DAB PUMPS S.p.A.
Via Marco Polo, 14 - 35035 Mestrino (PD), Italy
Tel. +39 049 5125000 - Fax +39 049 5125950
www.dabpumps.com

Receiver

From

Society
Reference
Address
Phone
Fax
E-mail

BMH 30/340.65 T

Curve tolerance according to ISO 9906

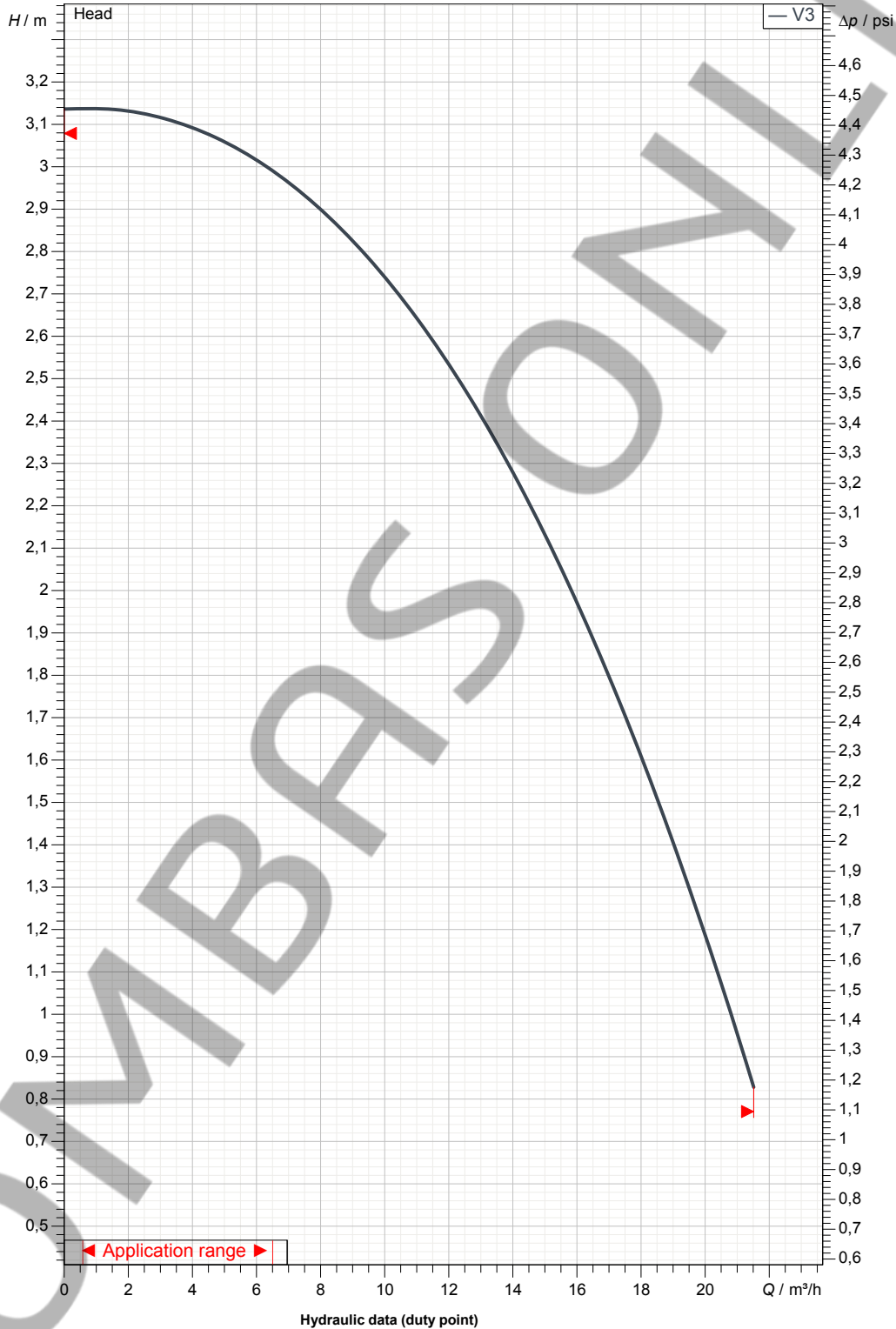

Suction side :
DN 65
PN 10

Discharge side :
DN 65
PN 10

Flow :

Head :

Rated speed :
1450 1/min

MAIN_PROJECT_TITLE

BUSINESS_PROCESS_IC

OWNER_

ISSUE_DATE



DIMENSIONAL DRAWING

31/07/2015

Page 3 / 3

DAB PUMPS S.p.A.
Via Marco Polo, 14 - 35035 Mestrino (PD), Italy
Tel. +39 049 5125000 - Fax +39 049 5125950
www.dabpumps.com

Receiver

From

Society
Reference
Address
Phone
Fax
E-mail

BMH 30/340.65 T

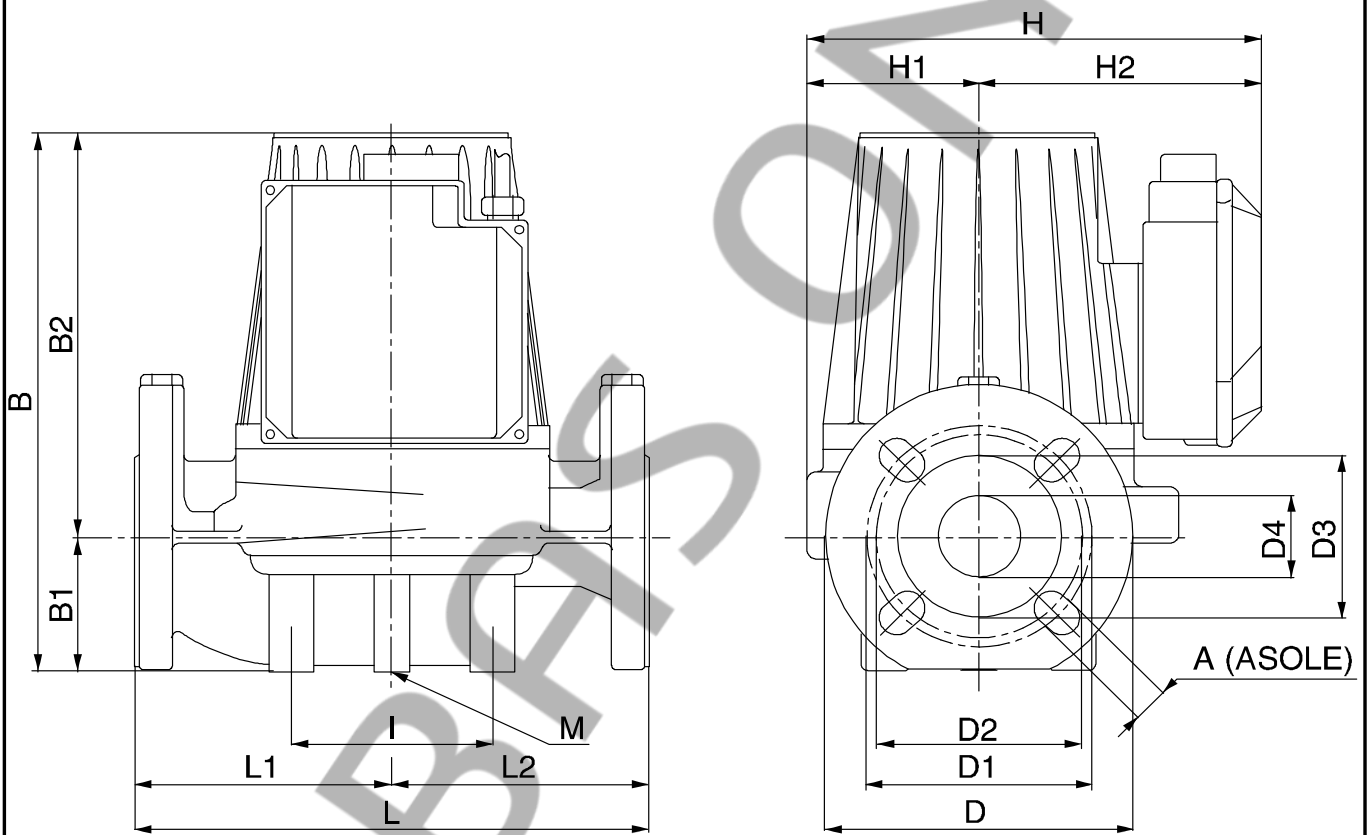

Dimensions in mm

Pump connection

1	A	18	I	100			
2	B	334	I1	-			Suction
3	B1	82	I2	-			DN 65
4	B2	252	I3	-			PN 10
5	D	185	L	340			
6	D1	145	L1	170			
7	D2	130	L2	170			Discharge
8	D3	110	M	M12			DN 65
9	D4	65					PN 10
10	H	259					
11	H1	100					
12	H2	159					

MAIN_PROJECT_TITLE	BUSINESS_PROCESS_ID	OWNER	ISSUE_DATE
--------------------	---------------------	-------	------------